



WARNING

- TO AVOID ELECTRIC SHOCK OR COMPONENT DAMAGE, DISCONNECT POWER BEFORE ATTEMPTING INSTALLATION OR SERVICING.
- THIS PRODUCT MUST BE INSTALLED IN ACCORDANCE WITH THE NATIONAL ELECTRIC CODE(NEC) AND ALL APPLICABLE FEDERAL, STATE AND LOCAL ELECTRIC CODES AND SAFETY STANDARDS.
- PLEASE FOLLOW THE CORRECT INSTALLATION INSTRUCTIONS TO INSTALL THE PRODUCT
- DO NOT USE THE PRODUCT UNDER WET LOCATION

This device complies with part 15 of the FCC Rules. Operation is subject to the following two conditions:

- (1) This device may not cause harmful interference,
- (2) this device must accept any interference received, including interference that may cause undesired operation.

Installation Instruction

① Carefully unpack the fixture from its packaging and check contents.

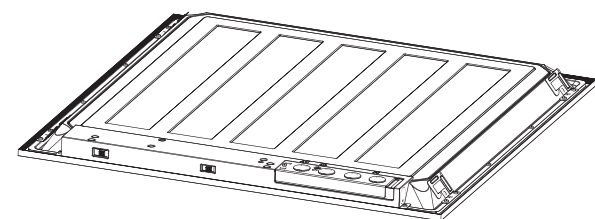

② Turn off power at circuit breaker.

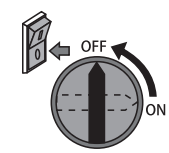

③ Locate all four earthquake clips on the back of luminaire. Twist each tab away from luminaire testing them on the T-bar.

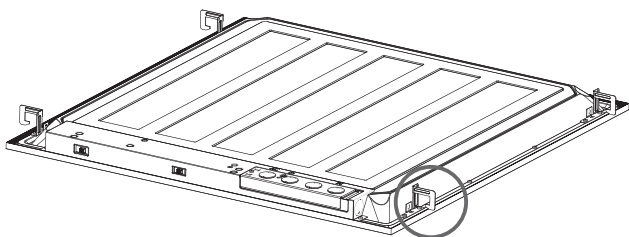

④ Rest the Luminaire on the T-Bar of the ceiling suspension system in the desired location.

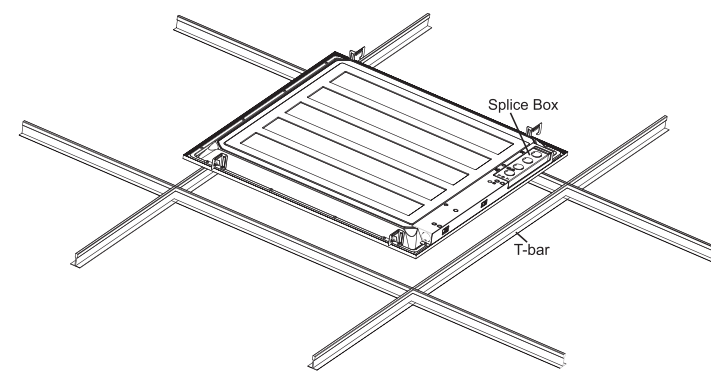

⑤ Open the connection box and connect the incoming electrical wires to the set of power wires black to black(Live), white to white(Neutral) and green to green(ground). See wiring diagram 1;

⑥ For 0-10V dimming, make sure connect the same wire color . See wiring diagram 2

<https://atgledlighting.com> 10588 Monte Vista Ave, Montclair, CA 91763

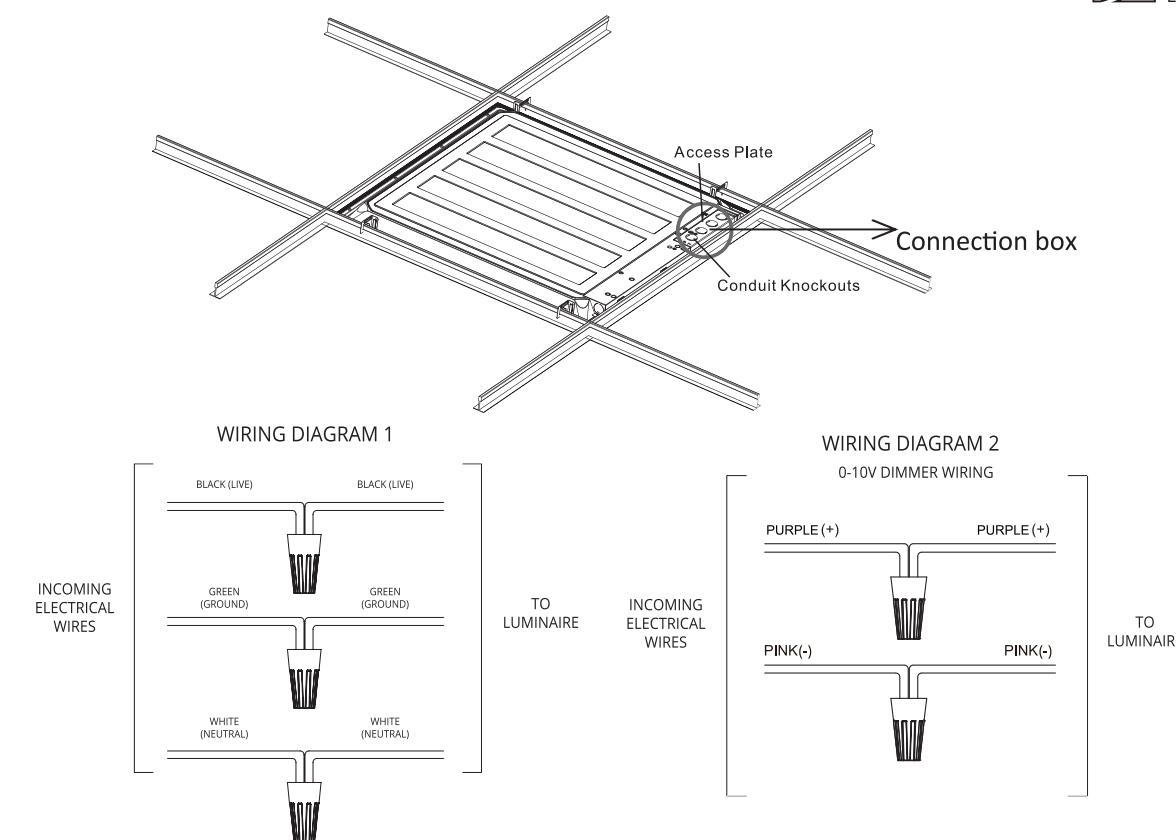

⑦ check the wiring, make sure everything is correct. Recover the connect on box.

⑧ For sensor compatible fixtures, remove the cover cap prior to installing sensor. Once cover cap is removed sensor can be plugged in and locked into place.

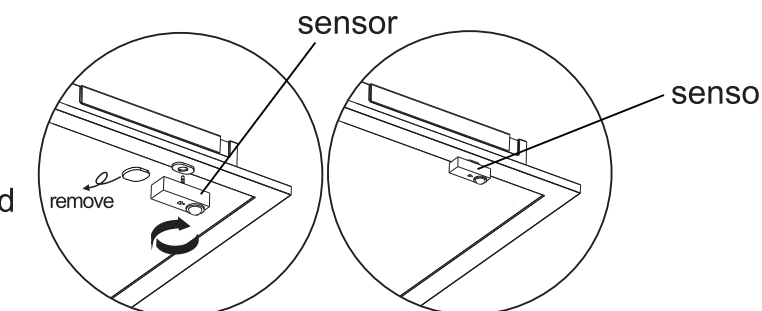

⑨ Select the CCT and wattage you need.
2X2&1X4: 20W-25W-30W, 3500K-4000K-5000K

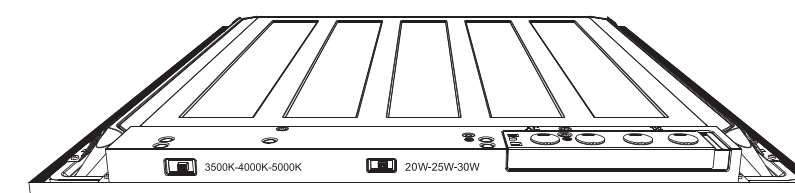

2X4: 30W-35W-40W, 3500K-4000K-5000K

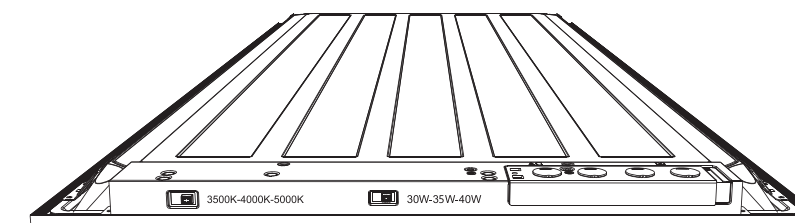

⑩ Turn on power to light up the luminaire.

<https://atgledlighting.com> 10588 Monte Vista Ave, Montclair, CA 91763